



LAMILUX SMOKE AND HEAT EXHAUST VENTILATION DEVICES
SAFETY THROUGH CERTIFIED SMOKE EXTRACTION SYSTEMS



The LAMILUX CI Philosophy

Our sole purpose is defined by the value we provide to our customers, placing their benefit at the heart of everything we do. This calls for unity, identity, and alignment between customer benefit and corporate direction.

These guiding principles underpin our business approach and the way we interact with our customers daily, encapsulated in the LAMILUX company philosophy:

Customised intelligence – serving the customer as a principle:

For us, this means delivering top performance and leading the way in all areas relevant to our customers, particularly as:

- Quality leader – delivering the highest value for the customer
- Innovation leader – staying ahead technologically
- Service leader – fast, straightforward, reliable, and friendly
- Expertise leader – offering the best technical and commercial advice
- Problem-solving leader – providing individual, tailored solutions



Glass Skylight FE Pyramid / Hipped

Modular Glass Skylight MS78

Flat Roof Access Hatch Comfort

Glass Skylight F100/FE Circular

Glass Roof Fire Resistance

Glass Roof PR60

Louvre Window AIRSTREAM

NATURAL SMOKE AND HEAT EXHAUST VENTILATION DEVICES

The primary function of natural smoke and heat exhaust ventilation devices (NSHEVs): In the event of a fire, to remove smoke and heat from rooms or buildings as quickly as possible and to ensure a low-smoke layer in the lower part of the room. This creates optimal conditions for the (self-)rescue of building occupants and for efficient firefighting. Natural smoke and heat exhaust ventilation devices therefore play a central role in the planning of fire protection concepts. The commonly used abbreviation SHEV stands for the general term smoke and heat exhaust ventilation system. These can include different system types (NSHEV, MSE, SCPS, GE, HE). LAMILUX daylight elements are used as natural smoke ventilation (NSHEV) and heat exhaust (WA) devices. The LAMILUX Group offers you a comprehensive portfolio of smoke and heat exhaust ventilation systems (SHEV systems).

SHEV - their importance

- They keep escape routes free of toxic flue gases.
- They create a low-smoke air layer and thus enable the fire brigade to have a clearer view for quick and targeted intervention for fire fighting and evacuation.
- They delay or prevent the explosion-like ignition of the flue gases (flash-over).
- They can prevent or delay a fire.
- They extend the stability of the building through thermal relief.
- They reduce consequential fire damage to buildings and all goods inside.

Fire progression without a smoke and heat exhaust ventilation device in an industrial hall



Fire progression with natural smoke and heat exhaust ventilation devices (NSHEVs) in an industrial hall

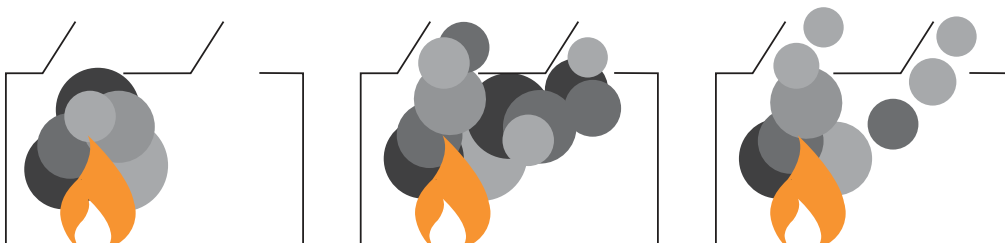



STANDARDS AND NORMS

Regulations on the subject of smoke extraction can be found in the various state building regulations, in standards, in technical building regulations and in special building regulations. The basics of fire protection are described in section 14 of the Model Building Regulations (MBO).

Structural systems must always be arranged, erected, modified and maintained in such a way as to prevent the occurrence of fire and the spread of fire and smoke. In the event of a fire, it must also be possible to rescue people and animals as well as to carry out effective extinguishing work.

The protection objectives taken into account in building regulations are: personal protection, neighbourhood protection and environmental protection. The type of building, its use and construction determine which standards must be implemented.

Overview of common standards

Standards	Objective
Building material grade DIN 4102-1, EN 13501-1	How well does a building material burn and continue to burn on its own? According to MBO, the fire behaviour of building materials must correspond to at least class E (normally flammable).
Fire resistance DIN 4102-2, EN 13501-2	Can a component (wall, door, etc.) withstand a fire without losing its function? Prevent fire spreading in the building (buildings are divided into fire compartments by fire walls with fire doors, etc.). Fires remain limited to these sections for a certain period of time).
Hard roofing DIN 4102-7, EN 13501-5	Can fire enter a building from the outside through the roof? Prevent fire from spreading from one building/part of a building to another via the roof.
Heat dissipation DIN 18230-1	Can the building's statics be protected by thermal relief in the event of fire? Heat dissipation in the event of fire, e.g. due to the opening of heat exchangers or melting of plastic surfaces (at $T < 300^{\circ}\text{C}$), to protect load-bearing components.
Structural fire protection on (large) roofs DIN 18234	Limits the spread of fire on large roofs when exposed to fire from below Avoid fire propagation at roof penetrations for a safer roof in the event of fire.
Smoke extraction DIN 18232, EN 12101	Early detection and targeted containment and removal of fire smoke The production of a low-smoke layer and the prevention of smoke ignition are requirements for tested smoke and heat exhaust ventilation systems.

LEGISLATIVE BASIS

Smoke extraction device (tested in accordance with DIN EN 12101-2)

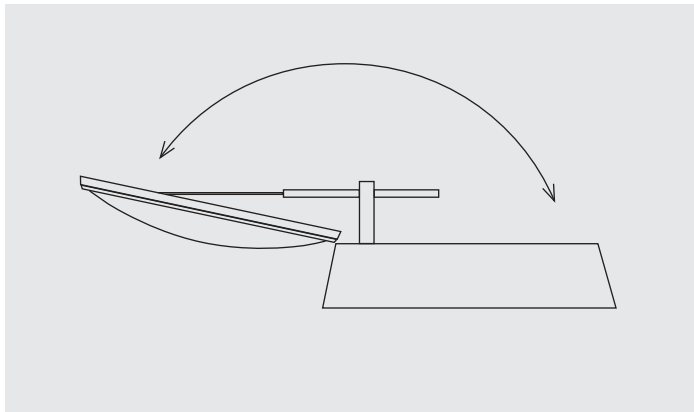

- Device tested in accordance with DIN EN 12101-2
- Key figures: Aerodynamically effective opening area A_a (EN) or A_w (DIN)
- The A_a value can be found in the manufacturer's declaration of performance

Typical applications:

Industrial buildings, assembly halls, sales buildings

Opening for smoke evacuation (no test required)

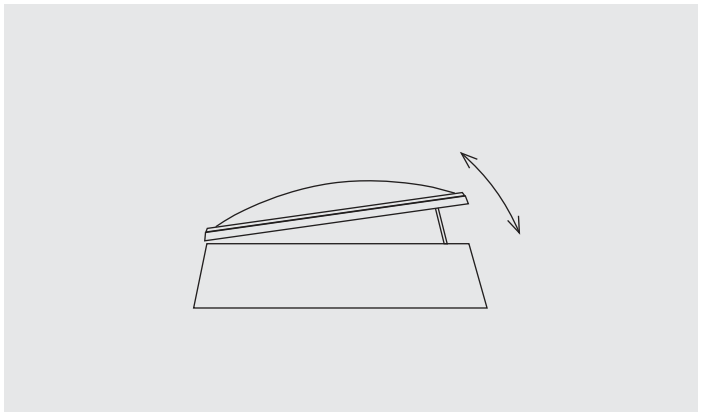

- No test required in accordance with MVTB Part D 2.2.3.9
- Key figures: Geometrically free opening area A_{geo}
- Calculation method: $A_{geo} [m^2] = A_{front} + A_{side} + A_{side}$

Typical applications:

Staircases

All LAMILUX devices shown in this brochure are available both as tested smoke extraction units and as smoke extraction openings.

Basic illustration of the geometrically free opening surface

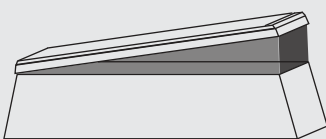

A_{front} : Clear width x Stroke

A_{side} : Clear width x Stroke x 0.5

$$A_{front} + A_{side} + A_{side} = A_{geo}$$

Caution: A_{geo} can never be larger than the clear area of the element

LAMILUX SMOKE LIFT ROOFLIGHT DOME F100 W

SMOKE AND HEAT EXHAUST EXTRACTION:

CO₂ 24V 48V 230V

VENTILATION:

bar 24V 48V 230V









LAMILUX smoke lifts meet the requirements of legal regulations and standards for certified smoke and heat exhaust ventilation systems (SHEVs). But it also meets the client's requirements, as they can expect an economical solution - either pneumatic or electrical, to suit their needs.

The LAMILUX Smoke Lift Rooflight Dome F100 W consists of an up-stand for the roof connection and a rooflight dome top section. A natural smoke and heat exhaust ventilation device (NRWG) is far more than an off-the-shelf product and offers great variety and flexibility: With our extensive range of accessories, we can adapt the LAMILUX Smoke Lift Rooflight Dome F100 W to the individual requirements and wishes of the customer as well as to structural conditions. We especially pay attention to ensuring the highest safety and reliability of our NSHEVs (natural smoke and heat exhaust ventilators) in the event of a fire!

Test parameters according to DIN EN 12101-2 and test results

Our NSHEVs reliably open to the SHEV position in less than 60 seconds...

	... and ensure high smoke emissions	Flow coefficient C_v from 0.60 to 0.75 Aerodynamically effective opening area A_a from 0.6 m ² to 3.94 m ²
	... after endurance testing (1,000 cycles in SHEV position and 10,000 cycles in ventilation position)	RE 50/1000 Ventilation 10,000
	... under snow load	SL 500 to SL 2400
	... at interior temperatures down to -15°C	T(-15)
	... after wind suction loads (up to 1,500 N/m ²)	WL 1500
	... under fire exposure	B 300

Your benefits

- Tested according to DIN EN 12101-2
- The LAMILUX Smoke Lift Rooflight Dome F100 W does not hit the roof nor does it need to be replaced even in the event test or false activations
- Combination with natural ventilation function (300/500 mm stroke)
- CO₂ cartridges in the NSHEV are not damaged during manual activation and maintenance
- Complies with DIN 18234 without additional effort (see page 35)
- Option for pneumatic and/or electrical remote activation



Available sizes

Roof opening size in cm	Inclined upstand				Steep upstand with spoiler			
	CO ₂	24V	48V	230V	CO ₂	24V	48V	230V
100/100	0,60	0,60	—	—	0,75	0,71	0,75	—
100/150	0,90	0,90	—	—	1,13	1,08	1,13	—
100/200	1,30	1,24	—	—	1,50	1,44	1,50	—
100/240	1,56	1,51	—	—	1,80	1,73	1,80	—
100/250	1,63	1,58	—	—	1,88	1,80	1,88	—
100/300	1,95	1,83*	—	—	2,25	2,07*	2,25	—
120/120	0,94	0,88	0,94	—	1,08	1,02	1,08	—
120/150	1,17	1,12	1,17	—	1,35	1,30	1,35	—
120/180	1,40	1,36	1,40	—	1,62	1,56	1,62	—
120/240	1,87	1,87	1,87	—	2,16	2,10	2,16	—
120/250	1,95	1,95	—	—	2,25	2,19	—	—
120/270	2,11	2,00*	—	—	2,43	2,27*	—	—
120/300	2,34	2,23*	2,34	—	2,70	2,56*	2,70	—
125/125	1,02	0,97	1,02	—	1,17	1,11	1,17	—
125/250	2,03	2,03	2,03	—	2,34	2,28	2,34	—
140/140	1,25	1,22	—	—	1,43	1,41	—	—
150/150	1,46	1,42	1,46	—	1,69	1,62	1,69	—
150/180	1,76	1,73	1,76	—	2,03	1,97	2,03	—
150/200	1,95	1,95	1,95	—	2,25	2,19	2,25	—
150/210	2,05	2,05	2,05	—	2,36	2,30	2,36	—
150/240	2,34	2,34	2,34	—	2,70	2,63	2,70	—
150/250	2,44	2,44	2,44	—	2,81	2,74	2,81	—
150/270	2,63	2,55*	—	—	3,04	2,88*	—	—
150/300	2,93	2,84*	2,93	—	3,38	3,20*	3,38	—
180/180	2,11	2,11	—	—	2,43	2,37	—	—
180/210	2,46	2,46	—	—	2,84	2,76	—	—
180/240	2,81	2,81	—	—	3,24	3,15	—	—
180/250	2,93	2,93	—	—	3,38	3,33	—	—
180/270	3,26	3,06*	—	—	3,55	3,50*	—	—
180/300	3,62	3,40*	—	—	3,94	3,89*	—	—
200/200	2,60	2,60	—	—	3,00	2,92	—	—

*Tandem fitting

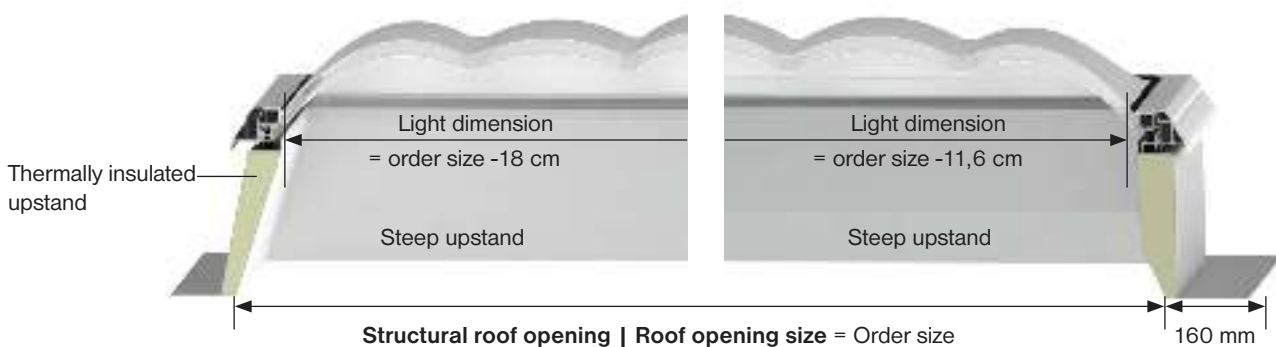



LAMILUX

SMOKE LIFT GLASS SKYLIGHT F100

SMOKE AND HEAT EXHAUST
EXTRACTION:

CO₂ 24V 48V 230V

VENTILATION:

bar 24V 48V 230V

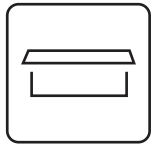

The LAMILUX Smoke Lift Glass Skylight F100 is ideally suited for industrial and administrative buildings. It combines the benefits of flat roof skylights with those of an electric smoke and heat exhaust ventilation device in accordance with DIN EN 12101-2.

The smoke lift achieves excellent heat and sound insulation values. Adapted to the individual requirements and wishes of the customer as well as the structural conditions, a natural smoke and heat exhaust ventilation device offers you safety and comfort for workspaces.

Test parameters according to DIN EN 12101-2 and test results

Our NSHEVs reliably open to the SHEV position in less than 60 seconds...

	... and ensure high smoke emissions	Flow coefficient Cv from 0.60 to 0.70 Aerodynamically effective opening area Aa from 0.6 m ² to 1.62 m ² *
	... after endurance testing (1,000 cycles in SHEV position and 10,000 cycles in ventilation position)	RE 1000 Ventilation 10,000
	... under snow load	SL 1000 to SL 2000
	... at interior temperatures down to -15°C	T(-15)
	... after wind suction loads (up to 1,500 N/m ²)	WL 1500
	... under fire exposure	B 300

Your benefits

- Available with 2- or 3-layer insulating glazing with U_g values from 1.1 to 0.7 W/(m²K)
- Tested according to DIN EN 12101-2
- Compliance with DIN 18234: Prevention of fire propagation on the roof without additional measures
- Compliance with EN 13501-5: Resistance to flying sparks
- Permanent fall-through protection
- Multi-stage ventilation as standard
- Problem-free closing after false activation
- Optionally available as roof access

Roof opening size in cm	A _a values (m ²) Inclined upstand		A _a values (m ²) Steep upstand	
	24V	48V	24V	48V
100/100	0.60	—	—	—
100/150	0.90	—	1.08	—
120/120	0.88	—	1.02	—
120/150	1.12	—	—	—
125/125	0.97	—	—	—
140/140	1.22	—	—	—
150/150*	1.42	—	1.62	—
150/150**	1.35	—	1.58	—

* only with 2-layer insulated glazing

** Triple glazing as tandem fitting



LAMILUX

SMOKE LIFT GLASS SKYLIGHT FE

SMOKE AND HEAT EXHAUST
EXTRACTION:
CO₂ 24V 48V 230V
VENTILATION:
bar 24V 48V 230V

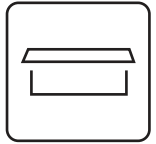

The LAMILUX Smoke Lift Glass Skylight FE opens up new architectural possibilities for high-quality administrative buildings. With an aluminium frame and for the highest energy requirements, it combines the advantages of flat roof windows with those of an electric smoke and heat exhaust ventilation device in accordance with DIN EN 12101-2.

In addition to excellent heat and sound insulation values, you can also benefit from the durability of our aluminium frames and the free colour design of the frames, in all RAL colours. A natural smoke and heat exhaust ventilation device gives you safety and comfort for work-spaces.

Test parameters according to DIN EN 12101-2 and test results

Our NSHEVs reliably open to the SHEV position in less than 60 seconds...

	... and ensure high smoke emissions	Flow coefficient C _v from 0.60 to 0.71 Aerodynamically effective opening area A _a from 0.6 m ² to 2.84 m ² *
	... after endurance testing (1,000 cycles in SHEV position and 10,000 cycles in ventilation position)	RE 1000 Ventilation 10,000
	... under snow load	SL 1000 to SL 2000
	... at interior temperatures down to -15°C	T(-15)
	... after wind suction loads (up to 1,500 N/m ²)	WL 1500
	... under fire exposure	B 300

Your benefits

- Available with 2- or 3-layer insulating glazing with U_g values from 1.1 to 0.6 W/(m²K)
- Tested according to DIN EN 12101-2
- Compliance with DIN 18234: Prevention of fire propagation on the roof without additional measures
- Compliance with EN 13501-5: Resistance to flying sparks
- Permanent fall-through protection
- Multi-stage ventilation as standard
- Problem-free closing after false activation
- Also available in a 3° inclined version

Roof opening size in cm 0°/3°	A _a values (m ²) oblique/steep		Roof opening size in cm 0°/3°	A _a values (m ²) oblique/steep	
	24V	48V		24V	48V
100/100	0.60		120/250	1.86	
100/150	0.90	1.08	120/300	2.23	
100/200*	1.24		125/125	0.97	1.08
100/200**	1.20		125/250	1.94	
100/240	1.44		150/150*	1.42	
100/250	1.53		150/150**	1.35	1.62
100/300	1.83		150/180	1.58	1.65
120/120	0.88	1.02	150/200	1.86	
120/150	1.12		150/210	1.98	
120/180*	1.36		150/240	2.27	
120/180**	1.30		150/250	2.36	
120/240	1.79		150/300	2.84	

* only with 2-layer insulated glazing

** Triple glazing as tandem fitting



SMOKE AND HEAT EXHAUST
EXTRACTION:

CO₂ 24V 48V 230V

VENTILATION:

bar 24V 48V 230V



LAMILUX

SMOKE LIFT GLASS ROOF PR60

Our suitable smoke and heat exhaust ventilation, the LAMILUX PR60 Smoke Lift Glass Roof, is ideally integrated into the glass roof construction and opens reliably and safely in the event of a fire. The NSHEV can be installed in the LAMILUX PR60 glass roof at inclinations from zero to 90 degrees.

Test parameters according to DIN EN 12101-2 and test results

Our NSHEVs reliably open to the SHEV position in less than 60 seconds...



...and ensure high smoke emissions

Flow coefficient C_v from 0.56 to 0.70

Aerodynamically effective opening area A_a from 0.14 m² to 4.20 m²



... after endurance testing (1,000 cycles in SHEV position and 10,000 cycles in ventilation position)

RE 50/1000 | Ventilation 10,000



...under snow load

SL 500 to 1000



... at interior temperatures down to -15°C

T(00) T(-05) T(-15)



... after wind suction loads (up to 1,500 N/m²)

WL 1500



... under fire exposure

B 300

Your benefits

- Sash width and height infinitely adjustable (up to 2.50 m each, with a maximum sash area of 3.00 m² using real glazing)
- Complies with the European standard DIN EN 12101-2 for smoke and heat exhaust ventilation systems
- Flexible selection of drive systems, either pneumatically operated or electrically operated in 24-volt version
- Also ideally suited for refurbishing older glassroof structures, as it can be integrated into systems from other manufacturers

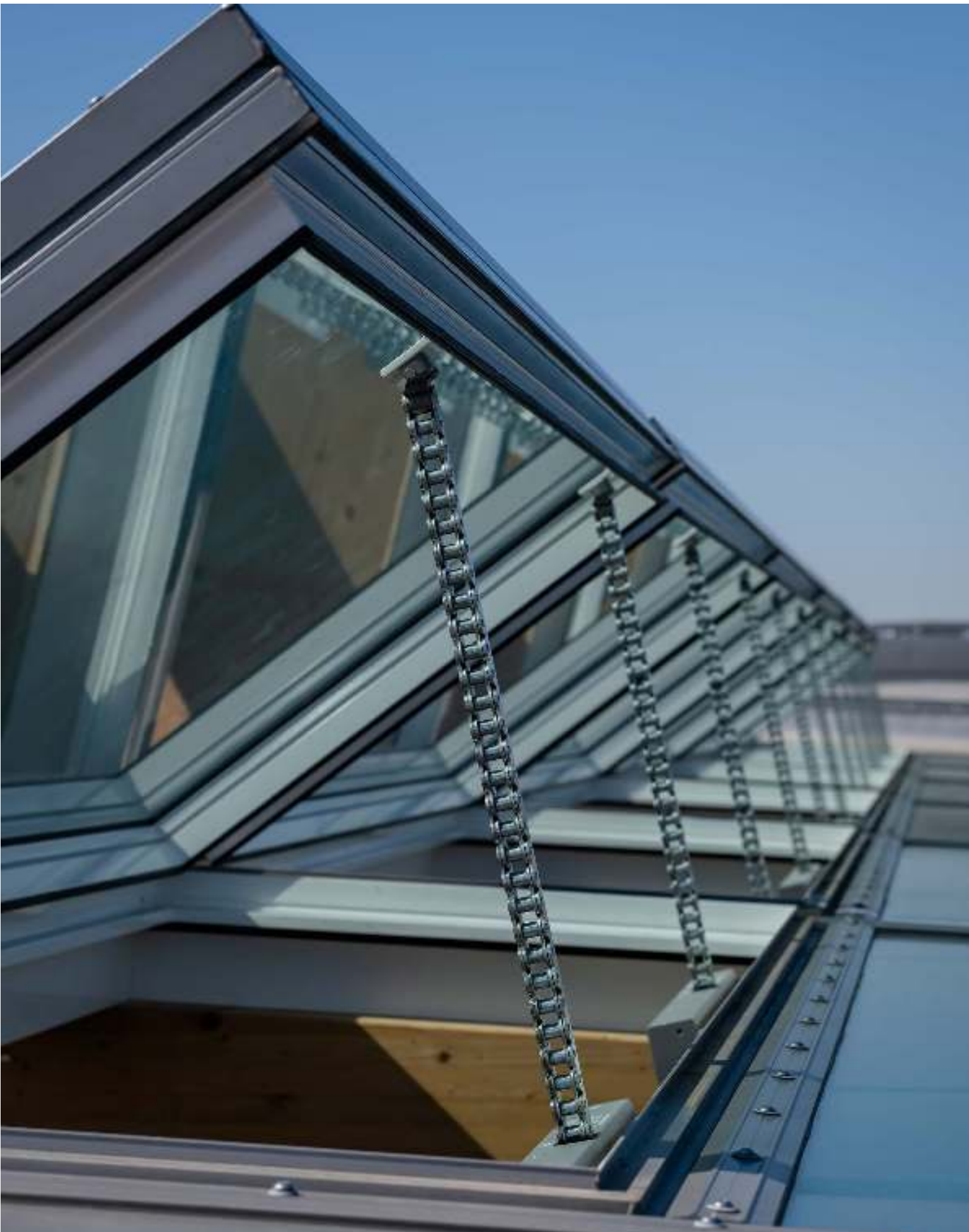



LAMILUX







SMOKE LIFT CONTINUOUS ROOFLIGHT B

Escape routes must be kept low in smoke for as long as possible in the event of a fire. LAMILUX Continuous Rooflights B and S achieve this with standard-compliant activation thanks to their effective smoke extraction effect. This allows both people to escape from inside the building and firefighters to enter for extinguishing. Smoke lift continuous rooflights B and S fulfil all the requirements of DIN EN 12101-2 in their function as a natural smoke and heat exhaust ventilation device.

Our continuous rooflight systems enable large-area aerodynamic smoke extraction surfaces and large-area full ventilation. Even with large dimensions, the flaps of the smoke lift prove to be an extremely stable overall system under strong wind loads, even when open. In the event of fire, they are opened quickly via thermal activation or CO₂ or electrical remote activation. If additional opening actuators are used, our NSHEVs can be used for daily aeration and ventilation.

Test parameters according to DIN EN 12101-2 and test results

Our NSHEVs reliably open to the SHEV position in less than 60 seconds...

	... and ensure high smoke emissions	Flow coefficient Cv from 0.60 to 0.67 Aerodynamically effective opening area Aa from 0.59 m ² to 7.52 m ²
	... after endurance testing (1,000 cycles in SHEV position and 10,000 cycles in ventilation position)	RE 1000 Ventilation 10,000
	... under snow load	SL 200 to SL 1100
	... at interior temperatures down to -5°C	up to T(-25)
	... after wind suction loads (up to 3,000 N/m ²)	WL 1500 to WL 3000
	... under fire exposure	B 300

Your benefits

- Thanks to patented linear burn-through protection, DIN 18234 is met even without gravel fill, preventing flame flashover
- Excellent thermal insulation values without thermal bridges
- Suitable as a meltable roof surface in accordance with DIN 18230, for heat removal
- Optional as "hard roofing" according to EN 13501-5: Resistant to flying sparks
- CO₂ cartridges in the NRWG are not damaged during manual activation and maintenance
- Many vent combinations – the perfect solution for every requirement



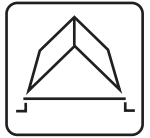

LAMILUX

SMOKE LIFT CONTINUOUS ROOFLIGHT S

Escape routes must be kept low in smoke for as long as possible in the event of a fire. LAMILUX Continuous Rooflights B and S achieve this with standard-compliant activation thanks to their effective smoke extraction effect. This allows both people to escape from inside the building and firefighters to enter for extinguishing. Smoke lift continuous rooflights B and S fulfil all the requirements of DIN EN 12101-2 in their function as a natural smoke and heat exhaust ventilation device.

Our continuous rooflight systems enable large-area aerodynamic smoke extraction surfaces and large-area full ventilation. Even with large dimensions, the flaps of the smoke lift prove to be an extremely stable overall system under strong wind loads, even when open. In the event of fire, they are opened quickly via thermal activation or CO₂ or electrical remote activation. If additional opening actuators are used, our NSHEVs can be used for daily aeration and ventilation.

Test parameters according to DIN EN 12101-2 and test results

Our NSHEVs reliably open to the SHEV position in less than 60 seconds...



... and ensure high smoke emissions

Flow coefficient Cv from 0.51 to 0.77

Aerodynamically effective opening area Aa from 0.32 m² to 6.50 m²



... after endurance testing (1,000 cycles in SHEV position and 10,000 cycles in ventilation position)

RE 1000 | Ventilation 10,000



... under snow load

SL 550 to SL 1100



... at interior temperatures down to -5°C

T(-5)



... after wind suction loads (up to 3,000 N/m²)

WL 1500 to WL 3000



... under fire exposure

B 300

Your benefits

- Thanks to patented linear burn-through protection, DIN 18234 is met even without gravel fill, preventing flame flashover
- Excellent thermal insulation values without thermal bridges
- Suitable as a meltable roof surface in accordance with DIN 18230, for heat removal
- Optional as "hard roofing" according to EN 13501-5: Resistant to flying sparks
- CO₂ cartridges in the NRWG are not damaged during manual activation and maintenance
- Many flap combinations – the perfect solution for every requirement



OVERVIEW OF THE AERO-DYNAMICALLY EFFECTIVE OPENING AREA OF THE VENTS DEPENDING ON THE WIDTH OF THE ROOFLIGHT

LAMILUX SMOKE LIFT CONTINUOUS ROOFLIGHT B

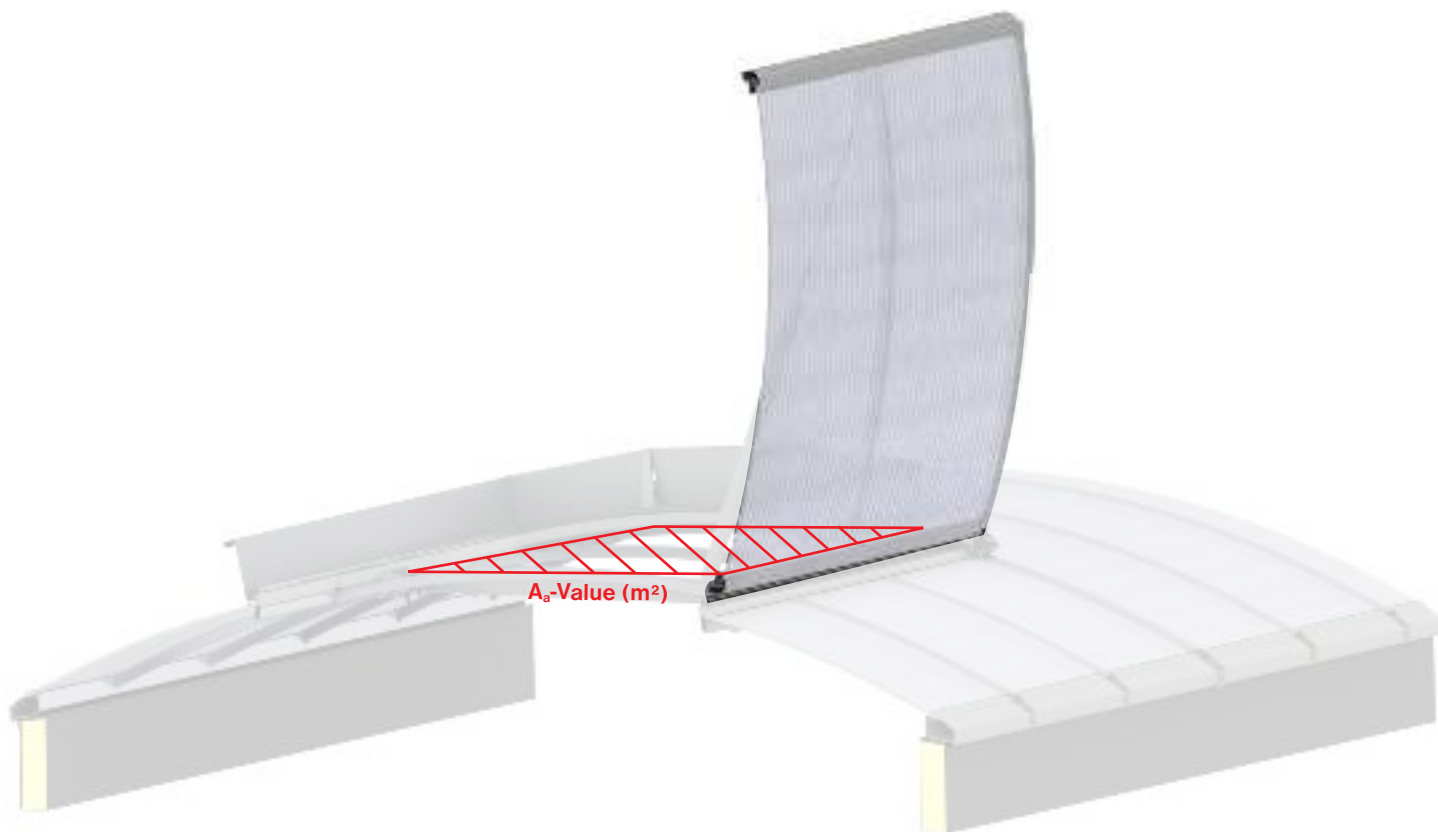

Continuous Rooflight B

From width of (m)	Aa-values (m ²)	
	Standard flap	Tandem serial
1,0	1,27	2,53
1,25	1,60	3,18
1,5	1,96	3,83
1,75	2,28	4,68
2,0	2,61	5,34
2,5	3,26	6,37
3,0	3,91	7,4

LAMILUX SMOKE LIFT CONTINUOUS ROOFLIGHT S

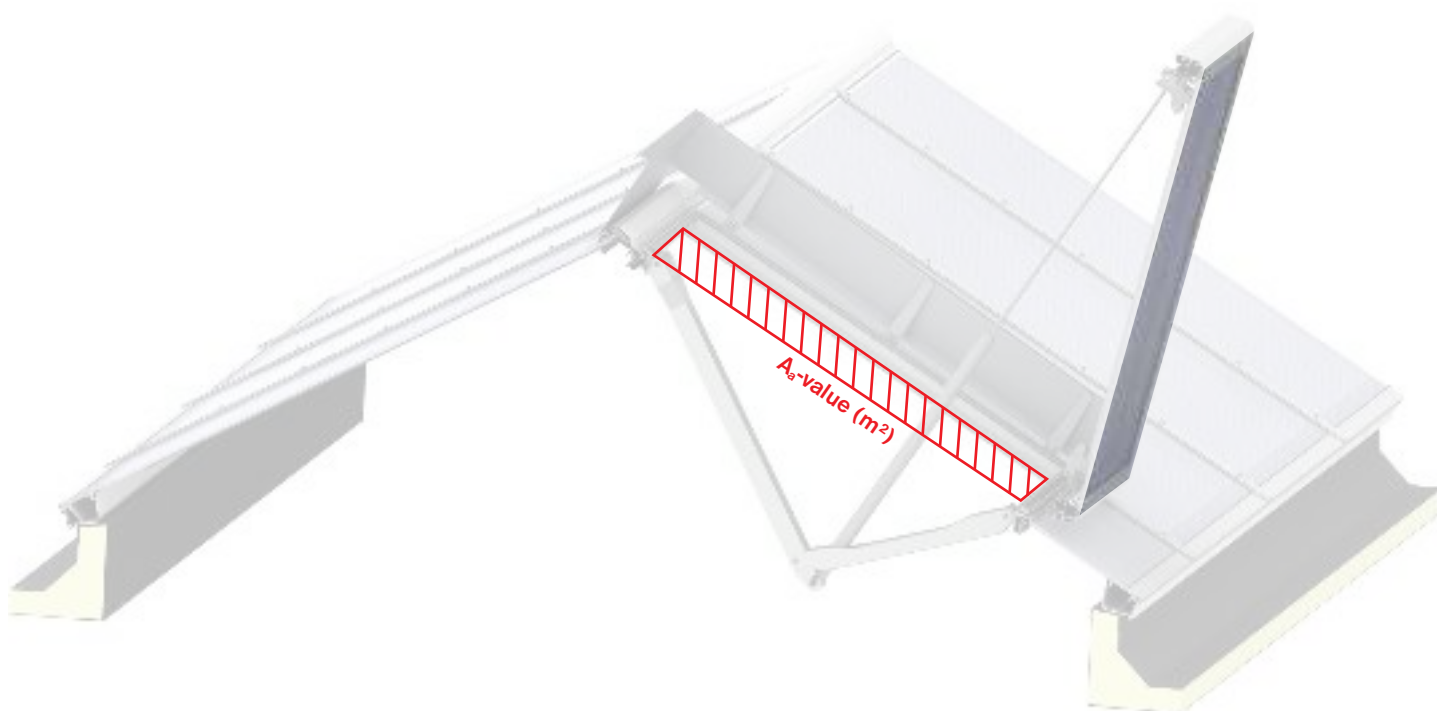

Continuous Rooflight S 30°/30°

Aa-values (m²)

From width (m)	Single flap	Double flap	Double flap Tandem serial
1,0	0,64	1,25	2,37
1,5	0,99	1,88	3,43
2,0	1,30	2,54	4,91
2,5	1,61	3,18	6,45
3,0	1,91	3,81	7,49

Continuous Rooflight S 45°/45°

Aa-values (m²)

From width (m)	Single flap	Double flap	Double flap Tandem serial
1,2	0,99	1,82	3,49
1,6	1,30	2,43	4,33
2,0	1,61	2,67	4,99
2,4	1,91	3,00	5,59

Continuous Rooflight SHED

Aa-values (m²)

From width (m)	Single flap	Double flap Tandem serial
0,6	0,64	1,21
1,0	0,99	1,88
1,3	1,30	2,49
1,6	1,61	3,03
2,0	1,91	3,59

FLAP SYSTEM FOR VENTILATION AND SHEVS

The combination flap for the continuous rooflight S enables effective ventilation, while optimum smoke extraction can be achieved in the event of a fire.



NEW Combi flap for Continuous Rooflight S

All smoke lift systems can be integrated as a single flap or as opposing double flaps. Similarly, it is possible to combine two flaps by arranging them directly next to each other. This flap combination acts as a natural smoke and heat exhaust ventilation device with a higher aerodynamic smoke extraction area, which is referred to as a tandem-serial single or double flap.

LAMILUX Smoke Lift Continuous Rooflight B



As single flap



As asymmetric double flap

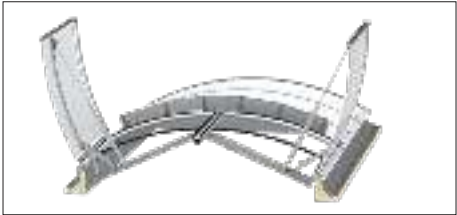

As symmetric double flap

LAMILUX Smoke Lift Continuous Rooflight S



As single flap



As double flap



As combi flap



As combi flap







LAMILUX SMOKE LIFT M FOR CONTINUOUS ROOFLIGHT W|R

LAMILUX smoke lifts meet the requirements of legal regulations and standards for fast and efficient smoke and heat extraction (SHEV). But it also meets the client's requirements, as they can expect an economical solution - either pneumatic or electrical, to suit their needs.

The LAMILUX Smoke Lift M for Continuous Rooflight W|R is a natural smoke and heat exhaust ventilation device (NSHEV) that is far more than an off-the-shelf product and offers great variety and flexibility: We tailor the LAMILUX Smoke Lift M to the specific, individual requirements and wishes of the customer, as well as to the structural conditions. We especially pay attention to ensuring the highest safety and reliability of our NSHEVs (natural smoke and heat exhaust ventilators) in the event of a fire!

Test parameters according to DIN EN 12101-2 and test results

Our NSHEVs reliably open to the SHEV position in less than 60 seconds...

	... and ensure high smoke emissions	Flow coefficient C_v of 0.55 Aerodynamically effective opening area A_a from 0.37 m ² to 1.7 m ²
	... after endurance testing (1,000 cycles in SHEV position and 10,000 cycles in ventilation position)	RE 50/1000 Ventilation 10,000
	... under snow load	SL 500 to SL 1000
	... at interior temperatures down to -15°C	T(-5) T(-15)
	... after wind suction loads (up to 1,500 N/m ²)	WL 1500
	... under fire exposure	B 300

Your benefits

- Tested according to DIN EN 12101-2
- The LAMILUX Smoke Lift M does not hit the roof or wall and does not need to be replaced even in the event of test or false activations
- Combination with natural ventilation function (300/500 mm stroke)
- CO₂ cartridges in the NRWG are not damaged during manual activation and maintenance
- Option for pneumatic and/or electrical remote activation



LAMILUX AND RODA

SMOKE AND HEAT EXHAUST
EXTRACTION:

CO₂ 24V 48V 230V

VENTILATION:

bar 24V 48V 230V

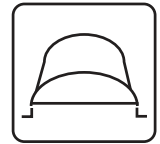

Since January 2018, roda Licht- und Lufttechnik GmbH has been part of the LAMILUX Group. The subsidiary's product portfolio covers the four core specialist areas of smoke and heat ventilation, industrial ventilation, daylight technology and translucent facade technology. roda handles all project planning up to on-site acceptance. Additionally, roda provides maintenance for SHEV systems from all manufacturers and renovations in all four core specialist areas.

LAMILUX and roda cooperate very closely in both development and sales. Benefits for you as a customer: A single point of contact, no interface issues, a broader product portfolio, and greater service capacity.







The first joint product is a thermally separated continuous rooflight with rainproof ventilation: the combination of the LAMILUX Continuous Rooflight B with the MEGAPHÖNIX double flap from roda. The element ensures all-weather ventilation through weather-protected side opening flaps. These open automatically as soon as the upper flaps close in the event of rain.

With a continuous rooflight width of up to three metres, the MEGAPHÖNIX can be mounted directly on the frame of the continuous rooflight. From a continuous rooflight width of more than three metres, the MEGAPHÖNIX is placed directly on the supporting rungs of the continuous rooflight without interruption as a "rider".

Another joint solution is the integration of the red lamella fans into the LAMILUX Continuous Rooflight S.

Test parameters according to DIN EN 12101-2 and test results

Our NSHEVs reliably open to the SHEV position in less than 60 seconds...

	...and ensure high smoke emissions	Flow coefficient C_v from 0.4 to 0.65 Aerodynamically effective opening area A_a from 0.325 m ² to 6.7 m ²
	... after endurance testing (1,000 cycles in SHEV position and 10,000 cycles in ventilation position)	RE 1000 Ventilation 10,000
	...under snow load	SL 300 to SL 9040
	... at interior temperatures down to -15°C	T (-5) T (-10) T (-15)
	... after wind suction loads	WL 750 to WL 4500
	... under fire exposure	B 300

Your benefits

- Tested according to DIN EN 12101-2
- With roda double flap systems, the full ventilation cross-section is available in ventilation mode at a 90° opening
- Suitable for daily ventilation, optionally usable as a multi-purpose fan for ventilation during bad weather
- CO₂ cartridges in the NRWG are not damaged during manual activation and maintenance
- Complies with DIN 18234 without additional effort



Phoenix



Megaphönix



Firefighters



Airstream

LAMILUX

BUILDING SMOKE CONTROL

We ensure safe and integrated smoke extraction in buildings of all sizes. We develop our control solutions – depending on individual safety requirements and building type – on an electrical or electro-pneumatic basis. From small control solutions for smoke extraction and energy efficiency to complex automation in large-scale projects – we offer all services from a single source, including cross-trade coordination: from planning and design to installation, commissioning and maintenance.

- Comprehensive approach to project-specific smoke extraction solutions with NSHEV, MSE and SCPS systems

- Planning, design and delivery of integrated control solutions
- Support and collaboration for architects and specialist planners in the area of building smoke control
- In-house manufacturing, installation, and maintenance of control and switchgear systems
- Installation of all cables (electrical systems) and pipes (pneumatic systems)

SHEV: Smoke and heat exhaust ventilation system

NSHEV Natural smoke extraction	MSE Mechanical smoke extraction	SCPS Smoke control pressure system	HE Heat exhaust
--	---	--	---------------------------



AIRPORT, MUNICH

- Control of all natural smoke extraction systems in combination with sun protection and climate optimisation in Terminal 2
- Connection to BMS “Fire Coordinator” and “Building Services – Climate Optimisation”
- Control of the venetian blind system via 230 LON bus modules
- Glass louvres for supply and exhaust openings
- Saddle Glass Roof RE60 KWS 60, surface inclination 15°
- Solar control insulating glass with PVB film Stopray Carat, 47% light transmission, g-value approx. 25%, Ug-value = 1.1 W/(m²K)



INTERCITY HOTEL, HANOVER

- Planning, design and installation of the smoke control pressurise system (SCPS) in the stairwell and fire service lift of the 17-storey building
- Installation of all control components, fire protection and louver flaps, and other elements
- Commissioning and adjustment of smoke control pressure systems
- Planning, coordination and execution of expert inspections

RELEVANCE OF MAINTENANCE OF SHEV DEVICES

Ensuring the safe function of SHEV systems in the event of a fire is the duty of the building owner or operator and is mandated by various laws, regulations, and standards. Normal environmental influences such as dust, dirt or moisture can cause SHEV systems to malfunction after just a few years.

If regular maintenance is neglected, authorities may impose fines or shut down operations, and warranty claims may be forfeited. If SHEV Systems fail during a fire, there is a risk of both civil and criminal consequences. That's why you should use the LAMILUX maintenance contract, which guarantees functionality in the case of fire. We maintain all systems regardless of manufacturer.

Your benefits at a glance



Decades of experience



Maintenance of all smoke and heat exhaust ventilation devices (independent of manufacturer)



Comprehensive and optimal service



Premium Service Card with 24-hour emergency hotline



You can find our LAMILUX planning guide for DIN 18234 here.
Also discover our interactive planning guide
at www.lamilux.de/din18234ip.

LIMITING FIRE SPREAD ON THE ROOF

DIN 18234 is the “evergreen” standard for flat roofs. We offer standard solutions to prevent fire spread on your flat roof. In recent years, the scope of the standard has expanded considerably. It is now required by building regulations not only for industrial buildings but also for assembly and retail spaces. It limits the spread of fire on large-area roofs if fire is exposed to it from below.

The measures defined in the standard include material and design specifications for the individual layers of the roof structure and their combination. There are further specifications for roof penetrations such as rooflight domes and continuous rooflights. LAMILUX rooflight domes with GRP upstands in particular are well suited for roofs in accordance with DIN 18234 and hardly require any additional measures.

In this way, we make a significant contribution to a safe roof in the event of a fire. Building operators also have a great chance of lower insurance premiums.

Design in accordance with DIN18234-4 without raised roof liner
Increased expenditure using the example of a PVC upstand:

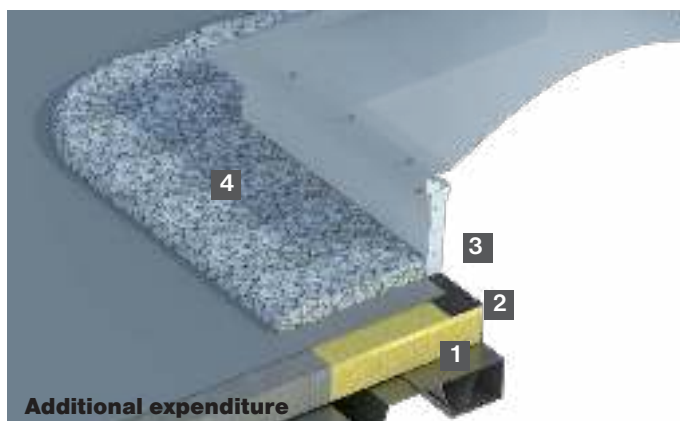

- 1** Thermal insulation in accordance with DIN 18234-3.4.1
2 Sheet metal edging of the thermal insulation
3 Disadvantage of thermal bridge
4 Heavy surface protection, e.g. gravel fill

LAMILUX solution:



- 1** GRP upstand with heat-insulated base flange and PVC connecting rail
- No thermal bridge
 - No gravel fill
 - No A1 insulation required
 - No additional edging





LAMILUX SKYLIGHTS

ROOFLIGHT F100 W



GLASS SKYLIGHT F100



GLASS SKYLIGHT FE



GLASS ARCHITECTURE



MODULAR GLASS SKYLIGHT MS78



FLAT ROOF ACCESS HATCHES



CONTINUOUS ROOFLIGHT



RENOVATION



SMOKE AND HEAT EXHAUST



BUILDING SMOKE EXTRACTION



RODA LIGHT AND AIR TECHNOLOGY



Scan this
to learn more
about
LAMILUX
skylights!

The technical data listed in this brochure correspond to the current status at the time of printing and are subject to change. Our technical specifications are based on calculations and supplier specifications, or have been determined by independent testing authorities within the scope of applicable standards.

Thermal transmission coefficients for our plastic glazing were calculated using the finite element method with reference values in accordance with DIN EN 673 for insulated glass. Taking into account practical experience and the specific characteristics of plastic, the temperature difference between the outer surfaces of the material was defined as 15 K. Functional values refer to test specimens and the dimensions used in testing only. We cannot provide any further guarantees of technical values. This particularly applies to changed installation conditions or if dimensions are re-measured on site.



LAMILUX Heinrich Strunz GmbH

Zehstraße 2 . PO Box 1540 . 95111 Rehau . Tel.: +49 (0) 92 83 / 5 95-0 . Fax +49 (0) 92 83 / 5 95-29 0
E-Mail: information@lamilux.de . www.lamilux.com

